

Lasers and Gaussian beams

Basic Gaussian beam imaging

In this example, we will consider the propagation of a Gaussian beam in a simple imaging system. In Chapter 1, it was shown that the $ABCD$ matrix relating object and image planes can be written as

$$\mathbf{M} = \begin{bmatrix} m & 0 \\ -1/f & 1/m \end{bmatrix} \quad (10.74)$$

where m is the transverse magnification and f is the focal length of the imaging lens. Using the $ABCD$ law and assuming $n = n' = 1$, we can propagate a Gaussian beam described by q in the object plane to a beam described by q' in the image plane via

$$q' = \frac{mq}{-1/f + \frac{1}{m}} \quad (10.75)$$

Using the definition of the q parameter, it is easy to separate Eq. (10.75) into its real and imaginary parts and find expressions for the spot size w' and wavefront radius of curvature R' in the paraxial image plane

$$w' = |m|w \quad (10.76)$$

$$R' = \frac{m^2 R f}{f - mR} \quad (10.77)$$

Several interesting conclusions can be drawn from the above relations. Not surprisingly, the ratio of the spot sizes is just the paraxial magnification. Perhaps less obvious is an implication of the image radius of curvature equation. Consider the case where we place the input beam waist in the object plane, so $R = \infty$. Taking the limit of Eq. (10.77) for this case, we find that $R' = -mf$. For the usual case of a positive lens with real object and image distances, f is positive and m is negative. Thus, R' is seen to be positive, which in the beam sign convention means that the image space beam has already passed through its waist before intersecting the paraxial image plane, i.e., the beam waist is inside the paraxial image location. This phenomenon is sometimes called the *focal shift*, since the point of maximum axial irradiance is not at the geometrical focal point. In order to have a beam waist in the paraxial image plane ($R' = \infty$), we must have a radius $R = fm$ in the object plane.

The focal shift phenomenon is more dramatic for “slow” beams with a small divergence angle, or in other words, beams with a small Fresnel number. (The Fresnel number for a circular aperture of radius a and wavefront radius of curvature R is given by $a^2/\lambda R$.) We can illustrate this using the interactive ABCD analysis spreadsheet in OSLO. We will select a lens from the catalog database with a focal length of about 500 mm and use the paraxial setup spreadsheet to set the paraxial magnification to -1 . Be sure to change the primary wavelength to $0.6328 \mu\text{m}$ and delete wavelengths 2 and 3 before setting the magnification. Using, for example, the Melles Griot lens MGLDX248, the lens prescription is

Gen	Setup	Wavelength	Field Points	Variables	Draw Off	Group	Notes
Lens: No name		Zoom	1 of 1	Efl	503.519128		
Ent beam radius	2.000000	object height	-1.000000	Primary wavln	0.632800		
SRF	RADIUS	THICKNESS	APERTURE RADIUS	GLASS	SPECIAL		
OBJ	0.000000	1.0060e+03	1.000000	AIR			
AST	MGLDX248	3.200000 F	22.500000 AF	FIXED F			
2		1.0060e+03	22.500000 F	AIR			
IMS	0.000000	0.000000	1.000000 S				

Using the interactive ABCD analysis spreadsheet, we will examine the propagation of a Gaussian beam through this lens. Use a waist size of 0.25 mm and a waist distance of 0 to place the incident beam waist at surface 0.

There are a few conventions to remember in using the Gaussian beam spreadsheet in OSLO.

- To use the spreadsheet, you must enter data in two of the four fields (w , w_0 , z , R) on the specification surface. The remaining 2 fields will be calculated automatically. The data entry field will be indicated by an asterisk (*) once you enter a value. It is not possible to enter impossible input data; the program will display an error message.
- Sign conventions. The waist position is entered relative to the specification surface. If the waist is to the left of the specification surface, it has a negative sign (if there are no mirrors). The sign convention for wavefront radius is the same as for surface radius of curvature. That is, considering a wavefront diverging to the right, the wavefront radius of curvature is negative. In most laser literature, such a divergent wavefront has a positive radius of curvature.
- OSLO uses a convention that source distances less than $1e8$ are considered finite, while source distances more than $1e8$ are considered infinite. In the case of Gaussian beam propagation, infinite distance cannot be handled, so OSLO uses a convention that when the object distance is greater than $1e8$, the beam waist is considered to be on surface 1. This makes it easier to compare Gaussian beam propagation with ordinary geometrical propagation, because when the object distance is infinite, the wavefront on surface 1 is plane for either case.
- The OSLO Gaussian beam spreadsheet compares the beam given on a specification surface to the beam on an evaluation surface. The default specification surface is the object surface, and the default evaluation surface is the image surface. However, there is no requirement that the specification surface be in object space, or even that the evaluation surface have a higher surface number than the specification surface. It is possible to make the specification surface an interior surface, and find the solution in either object or image space by just changing the evaluation surface number.

In the present example, the object distance is finite, so the waist is on the object surface (surface 0).

Beam Specification Surface: <input type="text" value="0"/>		Beam Evaluation Surface: <input type="text" value="3"/>			
Solution I		Solution II			
Spot size (w)	<input type="text" value="0.250000"/>	0.000000	Spot size (w)	<input type="text" value="0.250000"/>	0.000000
Waist ss (w0) *	<input type="text" value="0.250000"/>	0.000000	Waist ss (w0)	<input type="text" value="0.212834"/>	0.000000
Waist dist (z)*	<input type="text" value="0.000000"/>	0.000000	Waist dist (z)	<input type="text" value="-138.583415"/>	0.000000
Wvf radius (R)	<input type="text" value="0.000000"/>	0.000000	Wvf radius (R)	<input type="text" value="-503.519128"/>	0.000000
Diverg. (rad)	<input type="text" value="0.000806"/>	0.000000	Diverg. (rad)	<input type="text" value="0.000946"/>	0.000000
Rayleigh range	<input type="text" value="310.286885"/>	0.000000	Rayleigh range	<input type="text" value="224.886721"/>	0.000000
Wavelength number of beam	<input type="text" value="1"/>		Evaluation surface shift	<input type="text" value="0.000000"/>	
Wavelength	<input type="text" value="0.632800"/>		Beam meridian:	<input checked="" type="radio"/> y-z	<input type="radio"/> x-z
M-squared	<input type="text" value="1.000000"/>		<input type="button" value="Print beam data in text window"/>		
<input type="button" value="Plot beam spot size"/>		<input checked="" type="radio"/> Slider-wheel design <input type="radio"/> Current graphics window			

Now click the Print beam data in text window button to see a complete analysis on all surfaces.

```
*GAUSSIAN BEAM - YZ PLANE
WAVELENGTH = 0.632800      M-SQUARED = 1.000000
SRF  SPOT SIZE  DIVERGENCE  WAIST SIZE  WAIST DIST  INC RADIUS  RFR RADIUS  RAYLEIGH
RG
0    0.250000   0.000806    0.250000   --          --          --
310.286885
1    0.848204   0.000164    0.810525   1.5242e+03  -1.1017e+03  1.7545e+04
4.9415e+03
2    0.848050   0.000946    0.212834   867.397688  1.7575e+04  925.703167
224.886721
```

3 0.250000 0.000946 0.212834 -138.583415 -503.519128 -503.519128
 224.886721

The spreadsheet and surface-by-surface analysis confirm the above discussion: the spot size in the paraxial image plane is the same as the spot size in the object plane (since $|m| = 1$) and the output beam waist lies to the left of the paraxial image plane, as can be seen in the schematic beam spot size plot. Also note that, as expected, the output wavefront radius of curvature is equal to the focal length.

If you click the *Plot beam spot size* button, you will produce a graphical depiction of the beam propagation through the system. This is an anamorphic drawing in which the scale in the y -direction is greatly expanded so you can see the changing spot size. If you select the slider-wheel design option, a graphics slider will be created that lets you drag a cursor along the z -axis and displays the current spot size in the graphics window, as shown below.

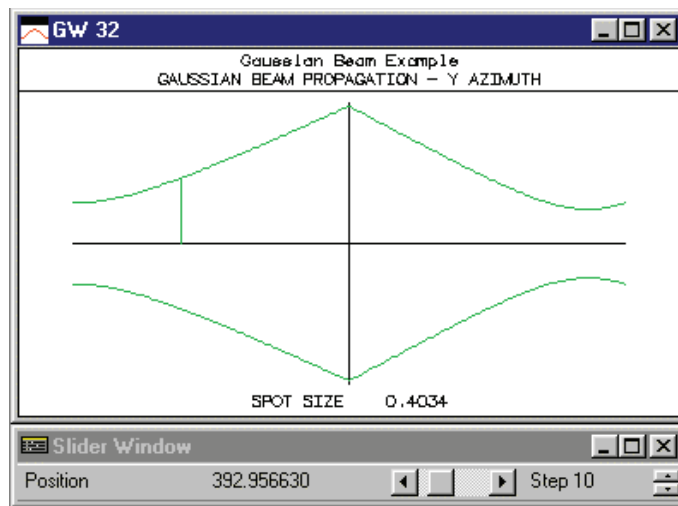

Point Spread Function calculation

We can use the point spread function computation in OSLO to verify the $ABCD$ analysis. From the Gaussian beam data, we see that the radius of curvature of the wavefront at surface 1 is -1.1017×10^3 mm and the spot size at surface 1 is 0.848204 mm. To set up an equivalent PSF calculation, we change the object distance (the thickness of surface 0) to match this wavefront radius of curvature value; then the geometric wavefront will have the same radius of curvature at the lens as the Gaussian beam we have just traced. Also, we set the setup operating conditions to use a Gaussian beam with an entering spot size equal to the Gaussian beam spot size at surface 1. We also increase the number of aperture divisions to 41.04, for increased accuracy. The entrance beam radius is set to 2 mm (2.35 spot sizes), so that the spot diagram grid approximates an untruncated incident Gaussian.

Aperture		Field		Conjugates	
Entr beam rad*	2.000000	Field angle	0.052007	Object dist	1.1017e+03
Object NA	0.001815	Object height*	-1.000000	Object to PP1	1.1028e+03
Ax. ray slope	-0.002160	Gaus image ht	0.840266	Gaus img dist	925.551802
Image NA	0.002160			PP2 to image	926.608955
Working f-nbr	231.430548			Magnification	-0.840266
Aperture divisions across pupil for spot diagram:					
Gaussian beam <input type="checkbox"/> Spot <input checked="" type="checkbox"/> 1/e ² radius on srf 1: sdx <input type="text" value="0.848204"/> sdy <input type="text" value="0.848204"/>					

After entering the data, we close the Setup spreadsheet and use the Evaluate>>Spread Function>>Plot PSF Scans command with default options to compute the PSF. We see from the

output (below) that the computed spot size is 0.2502 mm, essentially the same as the size predicted by the paraxial Gaussian beam trace.

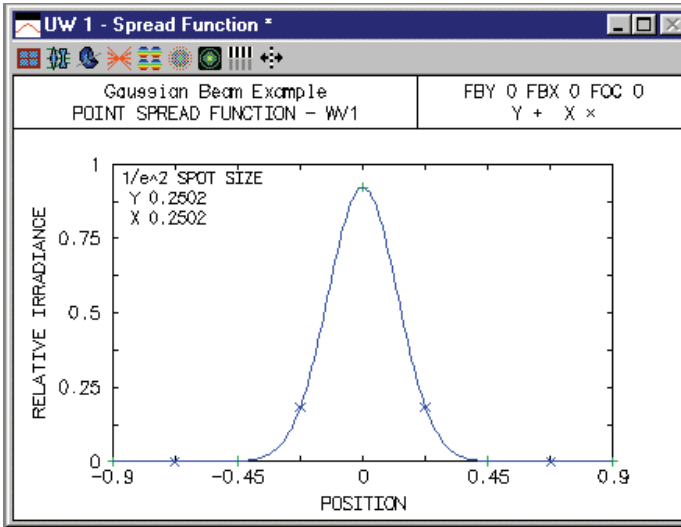

If we compute the central value of the point spread function at the paraxial image plane and at the waist distance ($z = -138.583$ mm) the ratio of the irradiances is 0.726, essentially the same value as computed from the fundamental Gaussian beam solution to the wave equation, which predicts an irradiance ratio of $(w_0/w)^2 = (0.213/0.25)^2 = 0.725$.

*POINT SPREAD FUNCTION

WAVELENGTH 1	Y	X	Z	PSF	AMPLITUDE	PHASE
--	--	--	--	0.921462	0.959928	-106.967090

*POINT SPREAD FUNCTION

WAVELENGTH 1	Y	X	Z	PSF	AMPLITUDE	PHASE
--	--	--	-138.583415	1.267969	1.126041	-75.772180

We can repeat the above plot with a focus shift of -138.583 to compare the spot size at the beam waist with that found using the Gaussian beam spreadsheet. We need to increase the scale of the plot to accommodate the increased peak PSF (1.268). Again using the Evaluate>>Spread Function>>Plot PSF Scans command, we find that the point spread function size at $z = -138.583$ is 0.2132, consistent with the waist calculation of 0.2128 mm.

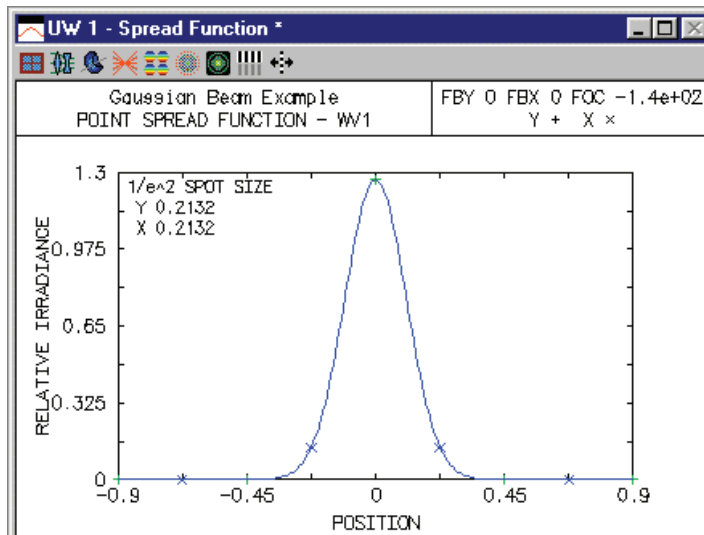

Truncated Gaussian beam

Now we will consider the effect of a finite aperture on the beam. If there is a diffracting aperture in the system that is not much larger than the spot size at the aperture, then we cannot use the usual Gaussian beam formulae to analyze the propagation of the beam. We need to compute the diffraction integrals taking into account the finite limits imposed by the aperture. Thus, we must use the OSLO PSF analysis routines based on the spot diagram. As an example, we will insert a real circular diaphragm (i.e. a checked aperture) just before the lens. The radius of the diaphragm will be equal to the $1/e^2$ spot size of the beam at that point. Make the aperture a checked aperture so that the beam is truncated at this point.

Gen	Setup	Wavelength	Field Points	Variables	Draw Off	Group	Notes
Lens: Gaussian Beam Example		Zoom	1 of 1	Efl	503.519128		
Ent beam radius		1.000000	Object height	-1.000000	Primary wavln		0.632800
SRF	RADIUS	THICKNESS	APERTURE RADIUS	GLASS	SPECIAL		
OBJ	0.000000	1.1017e+03	1.000000	AIR			
1	0.000000	0.000000	0.848204	K			
AST	MGLDX248	3.200000	F	22.500000	AF	FIXED	F
3		1.0060e+03		22.500000	F		
IMS	0.000000	0.000000	1.000000	S			

Now if we plot the x and y scans through the point spread function, we see that the spot size is no longer equal to the prediction of the Gaussian beam trace and the beam is no longer a Gaussian. By zooming the graphics window, you can see that the diffraction pattern exhibits evidence of the ring structure that is familiar from the analysis of uniformly illuminated pupils. (See, for example, Mahajan(8). Remember that OSLO normalizes the point spread function values to the peak of the perfect PSF for the same pupil size and focusing distance, so the irradiance normalizations are different for the above and below PSF plots.

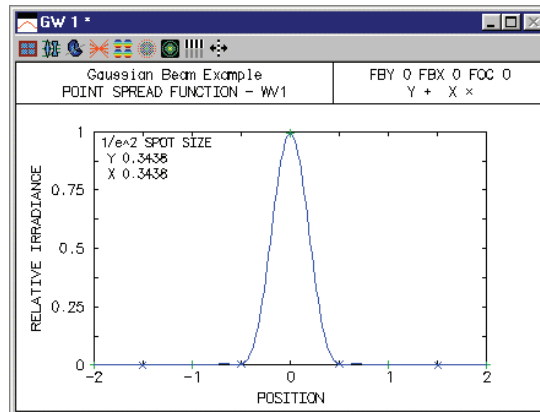

8 V. N. Mahajan, "Uniform versus Gaussian beams: a comparison of the effects of diffraction, obscuration, and aberrations," *J. Opt. Soc. Am. A* **3**, 470-485 (1986).

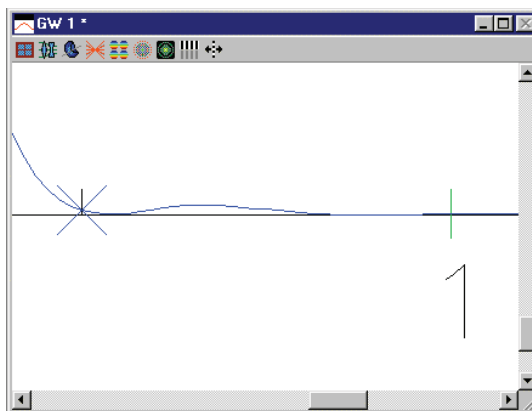

Tilted spherical mirror

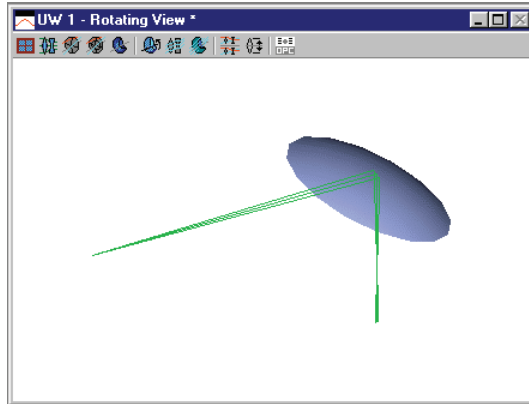

This example is taken from a paper by DeJager and Noethen(9) The system is a spherical mirror tilted 45 degrees. The input beam is circular but the output beam is highly astigmatic because of the large tilt. The system considered is a mirror with a radius of curvature of -50 mm, operating at a paraxial magnification of $-1/3$. Following DeJager and Noethen, enter the following system.

Gen	Setup	Wavelength	Field Points	Variables	Draw off	Group	Notes
Lens: Tilted Mirror Gaussian Beam Ex. Zoom 1 of 1 EFL -25.000000							
Ent beam radius		1.000000	Field angle	5.7296e-05	Primary wavln	0.632800	
SRF	RADIUS	THICKNESS	APERTURE RADIUS	GLASS	SPECIAL		
OBJ	0.000000	100.000000	1.0000e-04	AIR	F		
AST	-50.000000	-33.333300	20.000000	REFLECT	C		
IMS	0.000000	0.000000	3.4333e-05	S	F		

*TILT/DECENTER DATA

```
1 DT 1 DCX -- DCY -- DCZ --
   TLA 45.000000 TLB -- TLC --
```

Setup an on-axis object point and use the astigmatic Gaussian beam trace to propagate a circular beam with an object surface spot size of 1 mm. The input waist is at the object surface.

*SET OBJECT POINT

```
FBY FBX FBZ
-- -- --
FYRF FXRF FY FX
-- -- --
YC XC YFS XFS OPL REF SPH RAD
-- -- 11.859577 -21.358516 33.333300 -33.333300
```

*TRACE GAUSSIAN BEAM

```
WAVELENGTH = 0.632800 M-SQUARED = 1.000000
SRF Y SPT SIZE X SPT SIZE BEAM AZMTH Y RFR RAD X RFR RAD PHASE AZMTH
    Y WST SIZE X WST SIZE Y WST DST X WST DST
0 1.000000 1.000000 -- -- -- --
  1.000000 1.000000 -- -- -- --
1 1.414500 1.000203 -- 17.678937 35.360409 --
  0.003560 0.007121 -- 17.678713 35.358617 --
2 0.885686 0.057730 -- -15.654840 2.056608 --
  0.003560 0.007121 -- -15.654587 2.025317 --
```

These results are nearly identical with the image space beam calculated by DeJager and Noethen. Note the difference between the wavefront radii of curvature for the Gaussian beam and the geometric field sags (YFS and XFS of the reference ray output).

General astigmatism

This example is taken from the paper by Arnaud and Kogelnik mentioned earlier in this chapter. The system consists of two cylindrical lenses, with a relative orientation between their cylinder

9 D. DeJager and M. Noethen, "Gaussian beam parameters that use Coddington-based Y - NU paraprincipal ray tracing," Appl. Opt. **31**, 2199-2205 (1992); errata: Appl. Opt. **31**, 6602 (1992).

axes of 45 degrees. This is a nonorthogonal system, and we would expect that a stigmatic incident beam should suffer from general astigmatism after passing through the two lenses. The paper states that the two lenses have focal lengths of 250 mm and 200 mm, and are separated by 500 mm. It is also stated that the input beam, of wavelength $0.6328 \mu\text{m}$, has a waist that is located 500 mm in front of the first cylindrical lens. We can use the catalog database to find cylindrical lenses of the proper focal lengths and construct, for example, the following system.

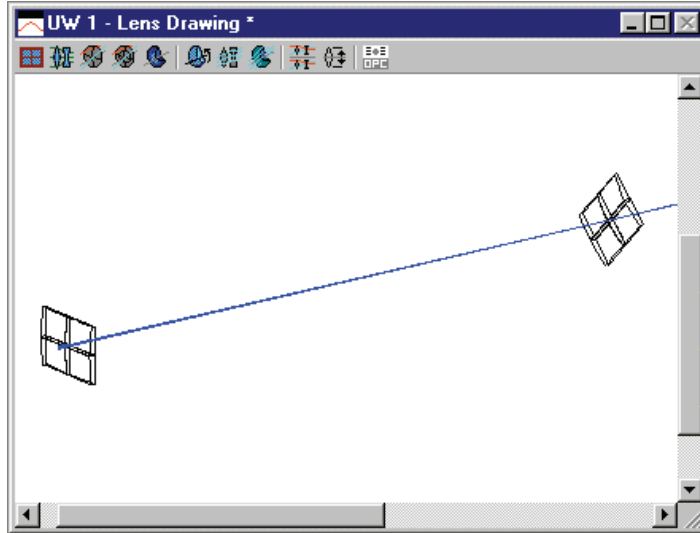

Gen	Setup	Wavelength	Field Points	Variables	Draw Off	Group	Notes
Lens: Arnaud/Kogelnik Example Lens		Zoom		1 of 1		Efl -977.798815	
Ent beam radius		1.000000		Field angle		5.7296e-05 Primary wavln 0.632800	
SRF	RADIUS	THICKNESS	APERTURE RADIUS	GLASS	SPECIAL		
OBJ	0.000000	500.000000	0.000500	AIR			
AST	MGLCP017	4.500000	F 11.250000	AFX	FIXED F	A	
2		500.000000	11.250000	FX	AIR	A	
3	MGLCP015	5.000000	F 11.250000	FX	FIXED F	CA	
4		609.500000	11.250000	FX	AIR	CA	
5	0.000000	100.000000	0.205230	S	AIR		
6	0.000000	100.000000	0.404114	S	AIR		
7	0.000000	100.000000	0.602998	S	AIR		
8	0.000000	100.000000	0.802091	S	AIR		
9	0.000000	100.000000	1.001277	S	AIR		
IMS	0.000000	0.000000	1.200462	S			

*TILT/DECENTER DATA

3	DT	1	DCX	--	DCY	--	DCZ	--
			TLA	--	TLB	--	TLC	45.000000
4	RCO	1	DCX	--	DCY	--	DCZ	--
	DT	1	TLA	--	TLB	--	TLC	--

Note that surface 4 has a return coordinates specification to restore the remaining surface to untilted coordinates. Surfaces 5 through 10 are dummy surfaces, placed at 100 mm intervals, to correspond to the observation planes in Fig. 6 of the Arnaud and Kogelnik paper. Unfortunately, the paper does not give the value of the input beam waist that was used to generate the photographs in Fig. 6. We will assume a circular input beam with a $250 \mu\text{m}$ diameter, i.e., a waist size of 0.125 mm .

```
>> trr 0
```

*SET OBJECT POINT

--	FBY	--	FBX	--	FBZ
FXRF		FXRF		FY	FX

```

--          --          --          --          OPL      REF SPH RAD
YC          XC          YFS          XFS          1.1144e+03  433.336428
--          --          -602.938147  65.736979

```

```
>> tgb ful all 0.125 0.125 0.0 0.0 0.0
```

```

*TRACE GAUSSIAN BEAM
WAVELENGTH = 0.632800      M-SQUARED = 1.000000
SRF  Y SPT SIZE  X SPT SIZE  BEAM AZMTH  Y RFR RAD  X RFR RAD  PHASE AZMTH
      Y WST SIZE  X WST SIZE                Y WST DST  X WST DST
0      0.125000  0.125000      --          --          --          --
      0.125000  0.125000
1      0.815345  0.815345      --          744.967305 -775.778310  --
      0.120145  0.125000
2      0.810420  0.820075      --          488.794855 -514.933799  --
      0.120145  0.125000
      478.051970 -502.970122
3      0.125654  1.621025  -45.000000  517.175680 -532.661386  15.166995
No waist information; beam has general astigmatism.
4      0.126339  1.613054  -44.520709  353.080556 -310.473989  17.350078
No waist information; beam has general astigmatism.
5      0.203564  1.434653  17.423235 -160.508935  446.318575  -7.393698
No waist information; beam has general astigmatism.
6      0.275956  1.415702  37.991769 -229.910974  407.348510  -3.418038
No waist information; beam has general astigmatism.
7      1.575798  0.277228  -32.997671 -310.935616  361.858250  -0.610825
No waist information; beam has general astigmatism.
8      1.866401  0.234750  -19.257529 -387.981434  355.943169  3.149425
No waist information; beam has general astigmatism.
9      2.230996  0.196775  -9.949000 -442.951614  611.649234  11.359960
No waist information; beam has general astigmatism.
10     2.636856  0.198718  -3.472671 -414.322269 -1.9493e+03  37.601892
No waist information; beam has general astigmatism.

```

These results are consistent with the photographs in Fig. 6 and the discussion of Section VII of the paper. Just after the second lens (surface 4) the beam is nearly horizontal. After the second cylindrical lens, the beam suffers from general astigmatism and no waist information can be calculated. As the beam propagates (surfaces 5 – 10), it changes size and rotates toward a more vertical orientation. The spot size and wavefront axes are never aligned as the beam propagates, since the BEAM AZMTH and PHASE AZMTH angle are never the same.

Using the values of the Y SPT SIZE, X SPT SIZE, and BEAM AZMTH computed on surfaces 5 through 10, we can draw the spot ellipse as the beam propagates beyond the cylindrical lenses. The ellipses, shown below, can be compared to the experimental results presented in Fig. 6 of the Arnaud and Kogelnik paper.

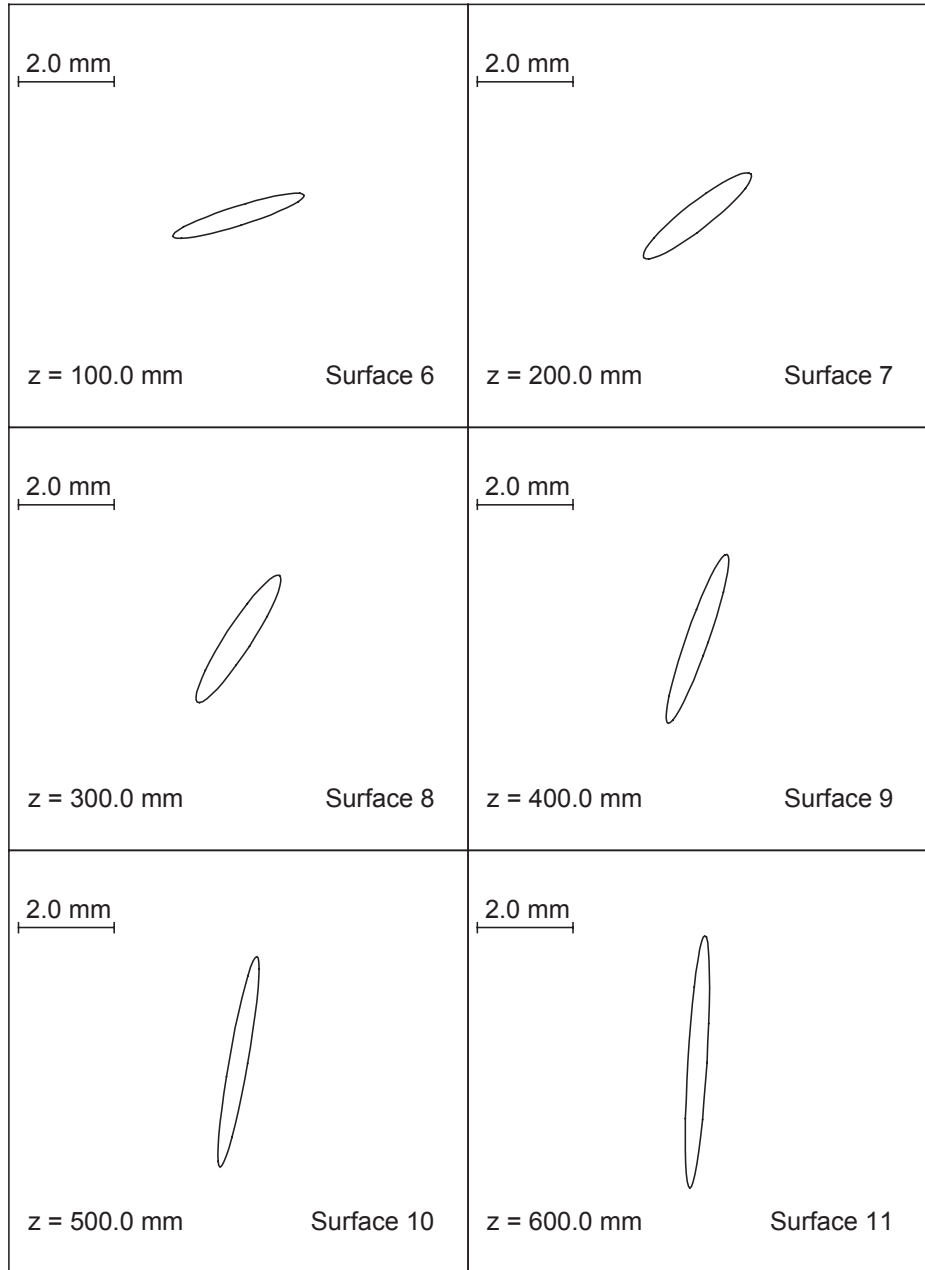

Laser cavity design

Usually, a laser consists of some gain medium which is placed in a cavity (usually two mirrors) to provide feedback. These laser cavities (or resonators) support *modes* of propagation; the fundamental mode is the Gaussian beam studied in this chapter. A resonator mode is a configuration of the optical field that is self-consistent, i.e., the beam parameters for the field are the same after each complete round trip of the wave through the cavity. Thus, the modes are axial standing wave patterns in the cavity. For a stable mode, the beam wavefront radius of curvature is equal to the radius of curvature of the mirror, when the field is incident upon each cavity mirror. In this example, we will design a simple Fabry-Perot cavity (two plane mirrors).

Since the cavity has plane mirrors and the wavefront radii of curvature at the mirrors are to equal to the mirror radii for a mode, the beam radii must be infinite on the mirrors. In other words, there must be a beam waist located at each mirror. To study the propagation of the beam from one mirror to the other, we only need to enter the optical system such that the object surface corresponds to one of the cavity mirrors and the image surface corresponds to the other mirror. Inside the cavity, we have the gain medium and a focusing lens. The gain medium is a 5 mm long, 0.5 mm diameter tube of neodymium-doped yttrium aluminum garnet (Nd:YAG, refractive index 1.82) and the lens is a 10 mm focal length, plano-convex fused silica lens from Melles Griot (Part No. 01LQF005). The lens is separated from the YAG rod by 0.5 mm and the second mirror (the image surface in our case) is 0.5 mm from the convex surface of the lens. We start with the YAG rod 5 mm from the object surface (the first mirror). Note that the lens has been reversed from its orientation in the catalog lens data base.

Gen	Setup	Wavelength	Field Points	Variables	Draw Off	Group	Notes
Lens: YAG laser cavity				Zoom	1 of 1	Efl	10.232836
Object num	aper	0.020000	Object height	-1.000000	Primary wavln	1.064000	
SRF	RADIUS	THICKNESS	APERTURE RADIUS	GLASS	SPECIAL		
OBJ	0.000000	5.000000	1.000000	AIR	F		
AST	0.000000	5.000000	0.250000	ND-YAG			
2	0.000000	0.500000	0.250000	AIR			
3	MGLQF005	2.700000	F	2.250000	FIXED	F	
4		0.500000		2.250000	AIR		
IMS	0.000000	0.000000	1.000000			F	

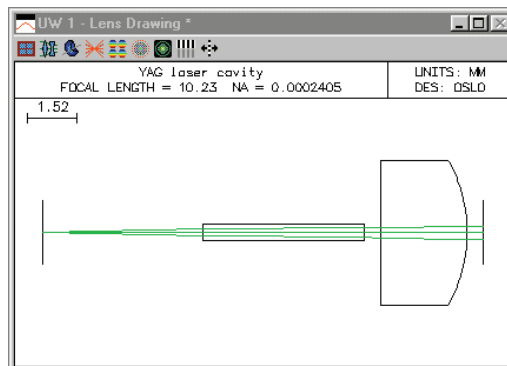

We need to find the correct separation from the object to the YAG rod in order to have a Gaussian beam waist on both mirrors. Thus our first variable is the thickness of surface 0. The other unknown quantity is what the beam waist size is for the mode. Unfortunately, the beam size is not one of the variable types in OSLO. We can, however, use a “dummy” variable to represent to waist size. For example, since surface 0 has a curvature of zero, changing the conic constant has no effect on the shape of the surface or the optical properties of the system. Thus, we can make the conic constant of surface 0 a variable, with the understanding that it represents the object space beam waist. Since a waist size of 0 is not allowed, we start with a value of 0.01.

*CONIC AND POLYNOMIAL ASPHERIC DATA

SRF	CC	AD	AE	AF	AG
0	0.010000	--	--	--	--

*VARIABLES

VB	SN	CF	TYP	MIN	MAX	DAMPING	INCR	VALUE
V 1	0	-	TH	4.000000	6.000000	1.000000	1.0002e-05	5.000000

V 2 0 - CC 1.0000e-05 0.500000 1.000000 1.0000e-05 0.010000
 We will use the astigmatic beam trace and SCP to compute the necessary operands. The beam will have a waist on surface 0 and a spot size (i.e., waist size) equal to the value of the object surface conic constant. One operand will be the waist distance for the image surface (surface 5). We want the image space waist to be at surface 5, so this value should be zero. Also, the beam should be confined to the YAG rod, so we target the beam size exiting the rod (surface 2) to be 2/3 of the radius of the rod. The SCP command “*yagmode” computes these operand components.

*OPERATING CONDITIONS: OPTIMIZATION

.....
 CCL/SCP operands command: *yagmode

```
*yagmode
set_preference(outp, off);
i = sbrow;
ssbuf_reset(i, 16);
trace_ref_ray(0.0, 0.0, 0.0, 0.0, 0.0);
trace_gaussian_beam(fu, all, cc[0], cc[0], 0.0, 0.0, 0.0);
Ocm[1] = ssb(9, 1); // Spot size on surface 2
Ocm[2] = ssb(16, 3); // Waist distance from image surface
ssbuf_reset(-i, 0);
set_preference(outp, on);
```

In terms of the above callback command, the operands are as follows:

OP	MODE	WGT	NAME	DEFINITION
1	Min	1.000000	Spotsize	OCM1-0.1667
2	Min	1.000000	Waistdist	OCM2

Once the operands and variables are properly entered, we can use the Ite command on the text output toolbar to iterate the design. After the optimization process has converged, we examine the variables and operands. Tracing the resulting mode beam confirms that the output waist is located on surface 5 and that the beam size at the YAG rod is the desired value.

*VARIABLES

VB	SN	CF	TYP	MIN	MAX	DAMPING	INCR	VALUE
V 1	0	-	TH	4.000000	6.000000	720.576161	1.0002e-05	5.070257
V 2	0	-	CC	1.0000e-05	0.500000	4.2833e+04	1.0000e-05	0.015956

*OPERANDS

OP	DEFINITION	MODE	WGT	NAME	VALUE	%CNTRB
O 1	"OCM1-0.1667"	M	1.000000	Spot size	9.7145e-16	5.16
O 2	"OCM2"	M	1.000000	waist dist	4.1662e-15	94.84

MIN ERROR: 3.0250e-15

*TRACE GAUSSIAN BEAM

WAVELENGTH = 1.064000		SRF	Y SPT SIZE	X SPT SIZE	BEAM AZMTH	Y RFR RAD	X RFR RAD	PHASE	AZMTH
			Y WST SIZE	X WST SIZE		Y WST DST	X WST DST		
		0	0.015956	0.015956	--	--	--	--	--
			0.015956	0.015956		--	--		
		1	0.108798	0.108798	--	-9.430706	-9.430706	--	--
			0.015956	0.015956		-9.227868	-9.227868		
		2	0.166700	0.166700	--	-7.889794	-7.889794	--	--
			0.015956	0.015956		-7.817510	-7.817510		
		3	0.177267	0.177267	--	-12.155806	-12.155806	--	--
			0.015956	0.015956		-12.057320	-12.057320		
		4	0.216670	0.216670	--	3.8427e+04	3.8427e+04	--	--
			0.216669	0.216669		0.500000	0.500000		
		5	0.216669	0.216669	--	4.6117e+18	4.6117e+18	--	--
			0.216669	0.216669		4.1662e-15	4.1662e-15		

Laser-diode collimating lens

This example illustrates the difference between paraxial and aplanatic ray aiming used for evaluation of high-speed lenses. The lens here is designed to take light from a laser diode and produce a collimated beam. It is a commercially available design available from Melles Griot as their part number 06GLC002. It is designed for a numerical aperture of 0.5 on the short conjugate side, and has a focal length of about 8mm.

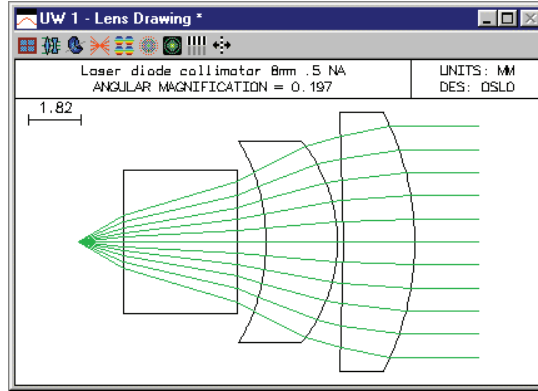

In traditional optical design, lenses are designed with the long conjugate side on the left. There are two reasons for this convention. First, there is a maximum distance that rays can be traced without loss of numerical accuracy using ordinary ray trace equations (in OSLO, this distance is 10^8 units). Many programs are set up to take object distances greater than this as being at infinity, for which special equations are used. When the long distance is on the image side, the system must be evaluated in afocal mode. This is not a problem for OSLO, which has built-in afocal mode support.

The second reason has to do with the way that rays are aimed at the lens from object space. In traditional programs, rays are aimed at a flat entrance pupil. This means that fractional coordinates of rays are proportional to their direction tangents in object space. When the object is at a great distance, this is ok, but actually fractional coordinates should be proportional to the direction cosines of rays in object space. We call this aplanatic ray aiming, as opposed to paraxial ray aiming. Aplanatic ray aiming was used in GENII for many years, and has been introduced into OSLO since the programs were merged in 1994. It has the advantage that OSLO can now be used to evaluate systems from short to long conjugate, which is not possible with a program that uses paraxial ray aiming.

The laser diode collimator is a fast enough system for the differences between paraxial and aplanatic ray aiming to be readily observable. The figures below shows the two cases (the system was changed to focal mode to produce these plots).

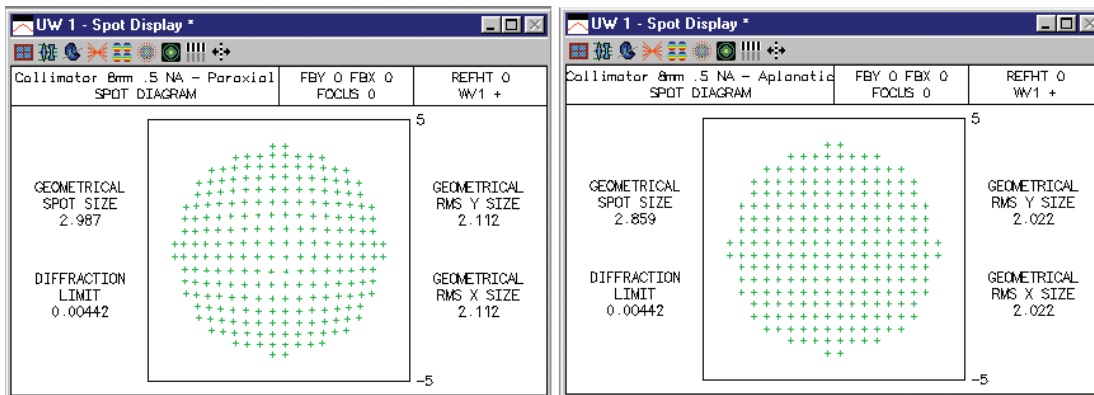

Beam circularizer for diode lasers

Most diode lasers emit asymmetric beams. The numerical aperture is different in the yz and xz planes, and often the beam has astigmatism, which is a separate issue. One way to make the beam circular is to use a pair of anamorphic prisms, as shown in this example. The prisms used here are available as Melles Griot part number 06GPU001. They work in collimated light (otherwise they would add astigmatism), so in an actual application the prisms must be used in combination with a collimator. Such a system is included as the file `diodassy.len`, described below.

The prisms have a vertex angle of 29.43333 degrees, a width of 12mm, and a maximum thickness perpendicular to the back face of 8.5mm. For a given entry angle to the first prism, the angle of the

second prism is fixed by the requirement that the beam emerge parallel to itself. The displacement of the beam depends on the prism separation. The listing below shows how the system should be set up in OSLO. Surfaces 4 and 6 are expressed in the coordinate system of surface 1 using a return_coordinates (**rc**) command. The **rc** command goes on the preceding surface and indicates that the coordinates of the next surface are to be taken according to the dcx, dcy, dcz, tla, tlb, and tlc relative to a base surface (here, surface 1).

In order to prevent a confusing drawing caused by the tilted surfaces, the surfaces themselves are marked not drawable (in the Surface Control spreadsheet). A plan view of the system shows just the ray trajectories. Note that although the drawing makes it look like there are only two surfaces, there are actually 4. The rays are close enough to normal incidence on the other two that the drawing doesn't show them.

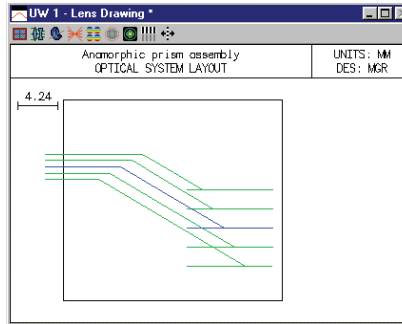

To substitute for the missing prism surfaces, the entire assembly has been placed in a box, using **bdi** (boundary data information) data. OSLO graphics routines can be instructed to put 3D objects on a drawing that are totally unrelated to the optical function of the depicted system. These objects are specified by a list of vertices (**vx**) and polygon faces (**pf**), as shown in the listing below. To enter such data yourself, open the lens file in the text editor and use the same scheme. The vertex and face information must be preceded by a **bdi** command, which gives the number of data items. The final solid-model drawing of the system is as follows:

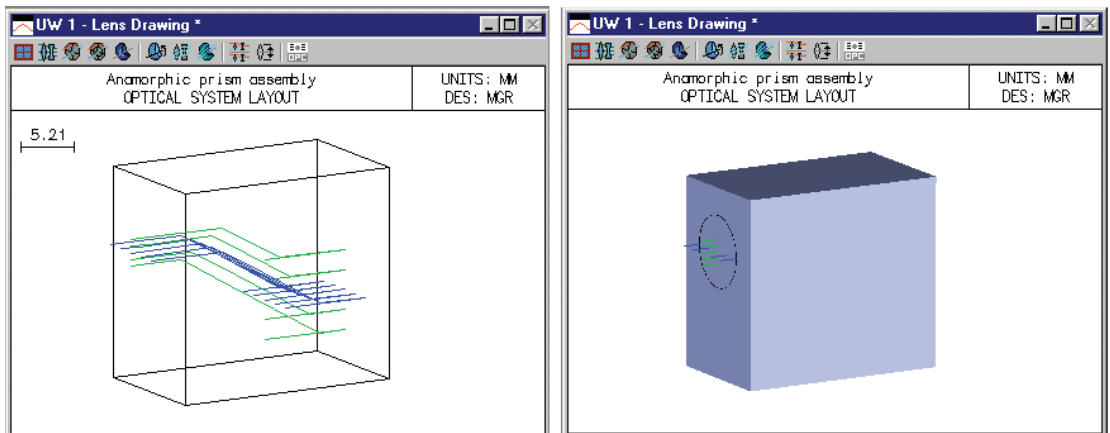

```
*LENS DATA
Anamorphic prism assembly
SRF      RADIUS      THICKNESS      APERTURE RADIUS      GLASS SPE      NOTE
0        --          1.0000e+20     1.0000e+18           AIR            *
1        --          6.000000      4.000000 AS          AIR            *
2        --          5.872557      1.0000e-06           SF11 C        *
3        --          --            1.0000e-06           AIR            *
4        --          5.872557      1.0000e-06           SF11 C        *
5        --          --            1.0000e-06           AIR            *
6        --          --            4.000000             AIR            * Prism assy
7        --          -0.003198     4.179133 s
```

*TILT/DECENTER DATA

2	DT	1	DCX	--	DCY	--	DCZ	--
			TLA	-59.800000	TLB	--	TLC	--
3	RCO	1	DCX	--	DCY	--	DCZ	--
	DT	1	TLA	29.433333	TLB	--	TLC	--
4	DT	1	DCX	--	DCY	-6.400000	DCZ	16.866459
			TLA	29.292833	TLB	--	TLC	--
5	RCO	1	DCX	--	DCY	--	DCZ	--
	DT	1	TLA	-29.433333	TLB	--	TLC	--
6	DT	1	DCX	--	DCY	-6.400000	DCZ	23.000000
			TLA	--	TLB	--	TLC	--

*SURFACE TAG DATA

1	LMO	EGR	(6 surfaces)
1	DRW	AP	
6	DRW	AP	

*BOUNDARY DRAWING DATA

SRF 1:

VX NBR	X	Y	Z	COORD	SURF
1	7.000000	7.000000	--	1	1
2	-7.000000	7.000000	--	1	1
3	-7.000000	-14.000000	--	1	1
4	7.000000	-14.000000	--	1	1
5	7.000000	7.000000	23.000000	1	1
6	-7.000000	7.000000	23.000000	1	1
7	-7.000000	-14.000000	23.000000	1	1
8	7.000000	-14.000000	23.000000	1	1

PF NBR	VX1	VX2	VX3	VX4
1	1	2	3	4
2	1	5	6	2
3	5	8	7	6
4	8	7	3	4
5	1	4	8	5
6	2	3	7	6

Shaping a diode laser beam

This file combines a diode-laser collimator (diocoll.len), a cylindrical lens, and an anamorphic prism assembly (anaprism.len) to create an overall system that converts the light from a hypothetical diode laser having a beam divergence ratio of 3:1 and 10 microns of astigmatism into a collimated circular Gaussian beam having a wavefront quality of better than 0.25λ . The diode is assumed to be single mode, and to have a numerical aperture in the xz plane of 0.3, and a numerical aperture in the yz plane of 0.1. The general layout of the system is as shown below. For additional information on the collimator see p 345 and for additional information on the prism assembly see p 346

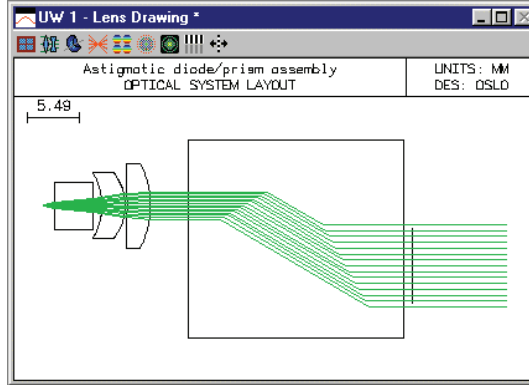

```
*LENS DATA
Astigmatic diode/prism assembly
SRF      RADIUS      THICKNESS  APERTURE  RADIUS      GLASS  SPE  NOTE
0         --         1.578414  1.0000e-06  AIR
1  ELEMENT GRP  10.200000  2.500000  A  SF11  C  *
6  Collimator  3.000000  4.500000  AIR
7  ELEMENT      1.000000  4.000000  BK7  C  *
8  Astig corr   --         4.000000  AIR  * Astig corr
9  ELEMENT GRP  17.745114  4.000000  AIR  *
14 Prism assy  --         4.000000  AIR  * Prism assy
15 ELEMENT      1.000000  4.000000  BK7  C  *
16 Out window  --         4.000000  AIR
17 --         --         2.515146  S
```

The astigmatism of the source is listed as the general operating condition **sasd** on the general operating conditions, as shown below. The value is the distance between the apparent source locations in the yz and xz meridians, 0.01 millimeters in the present example.

*OPERATING CONDITIONS: GENERAL

```
.
.
Source astigmatic dist: 0.010000  Ray aiming mode:  Aplanatic
Temperature:           20.000000  Pressure:         1.000000
```

The numerical aperture of the system is listed as 0.3 on the surface data spreadsheet. This tacitly assumes that the beam is circular. The ellipticity of the beam is indicated in the spot diagram operating conditions, since that is the place where it is important. The spot size in the y -direction is called **ssy**, and the spot size in the x direction is called **ssx**. Since the diode aperture is specified in NA, the spot size must be given as $ss = th[0] * \tan(\text{asin}(NA))$. Which yields $ssy = .159$, $ssx = .496$. The data below show the results of a spot diagram. Note that since the system is afocal, the spot data appears in angular measure (radians). Note also that the spot is much larger in the x direction than the y direction, as confirmed by the plot.

```
*SPOT DIAGRAM: MONOCHROMATIC APODIZED
APDIV  11.050000
WAVELENGTH 1
WAV WEIGHTS:
WW1
```



```

1.000000
GAU  SSY      SSX
0.100000  0.300000
NUMBER OF RAYS TRACED:
  WV1
  96
PER CENT WEIGHTED RAY TRANSMISSION:      6.532767

*SPOT SIZES
GEO RMS YA  GEO RMS XA  GEO RMS RA  DIFFR LIMIT  CENTYA  CENTXA
1.3927e-06  9.4077e-06  9.5102e-06  6.8377e-05  --      --

*WAVEFRONT RS
WAVELENGTH 1
PKVAL OPD      RMS OPD  STREHL RATIO  RSY      RSX      RSZ
0.031658      0.007022  0.998711  1.1417e-10  --      --
    
```

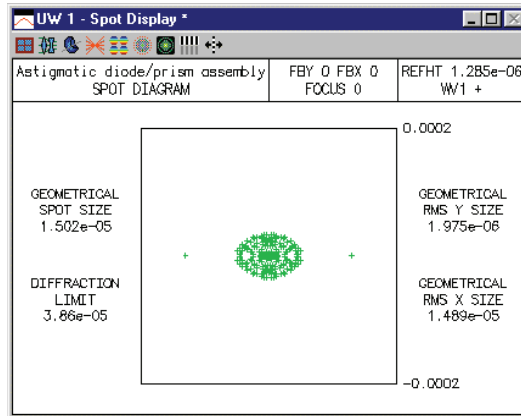

Spot diagrams only show the intersection points of rays with the image surface, not the ray weights. In the present case, the different *ssx* and *ssy* values put different weights on the rays (you can confirm this using the Calculate >> Display spot diagram command and selecting ray weights). The weights affect calculations such as energy distributions, and more particularly Fourier transforms, which are used to compute the intensity distribution in the emergent beam. The plot below shows the point spread function (i.e. the far-field intensity distribution) for the present system. The abscissa is in radians, since the evaluation is in afocal mode.

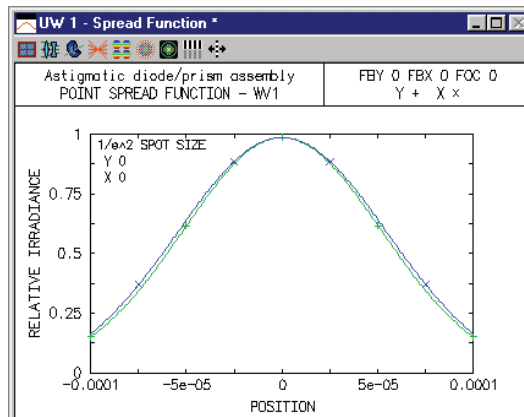

Gaussian beam movie

OSLO contains commands for making and viewing movies. Movies are sequences of graphics displays ("frames") that are saved in a single file that can be "played back" using the Show_movie command, which is executed when you select a movie from the User >> Movies submenu. As an example, the file gbmovie.mov is shipped with all versions of OSLO. It illustrates Gaussian beam propagation through a system where there are two lenses within the Rayleigh range of the beam. In the movie, a laser emitting a collimated beam having a spot size that ranges between .02 and .5 mm is placed at the focal point of a singlet lens that is separated from another identical singlet by its focal length. To run the movie, select the Gaussian Beam entry on the Movies submenu, or try the command

```
show_movie gbmovie fab 0 10
```

A typical output screen is shown below.

You can make movies yourself. There are two ways to make a movie. One, available in all versions of OSLO, is to open a movie file and save frames in it one by one. You can use SCP to automate the process. The commands required for this are as follows:

```
Open_movie(char Filename[])
Save_frame(void) /* repeat as needed */
Close_movie(void)
```

For more information on movies, see the OSLO Help system.

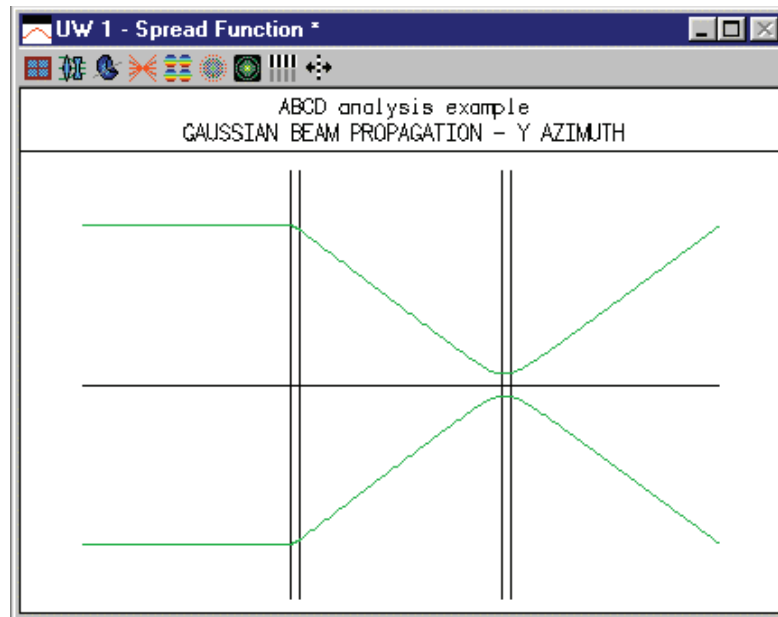

Aplanatic laser focusing system

This system is designed in chapter 5 using Melles Griot catalog lenses. Here, a small “light pipe” has been added in the image plane to simulate a fiber. The light pipe has a diameter of 0.005mm, and a length of 0.05mm, so it is similar in geometrical size to the one postulated for the example. To see the fiber, you must make a special drawing in which you limit the surfaces drawn to 6 and 7, then you can zoom in as much as possible. The result is the second drawing below.

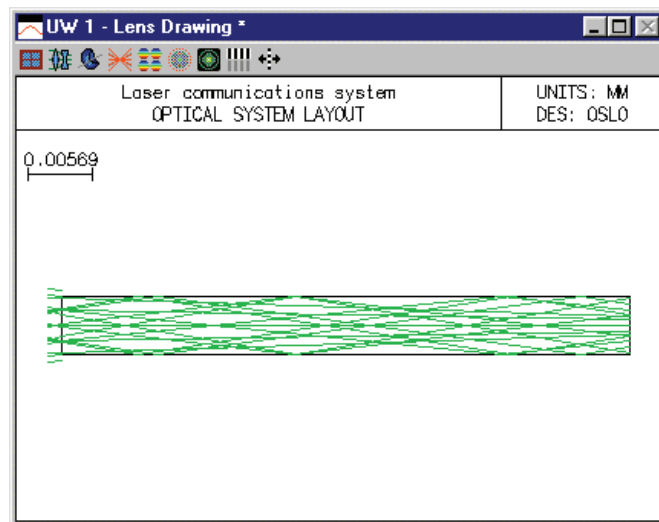
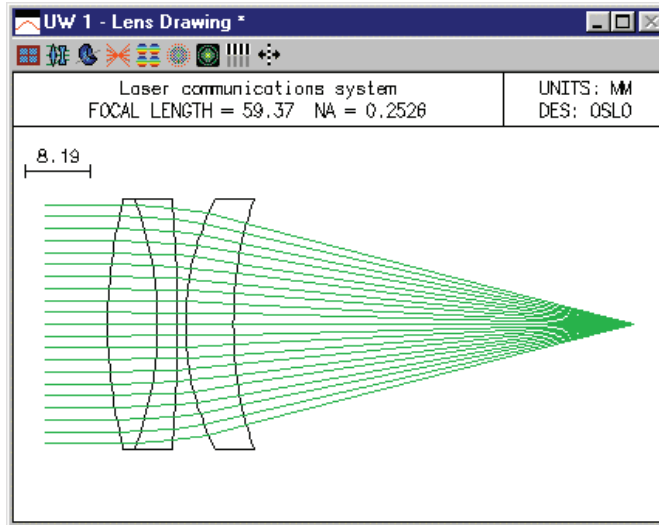

You can readily see that the extreme rays miss the edge of the fiber. Of course no particular quantitative information can be obtained from this, since the system is close to the diffraction limit. If you want to obtain detailed information on the coupling into the fiber, you should use the Options >> Fiber coupling command. If you want to use this command, you should first remove the light pipe (surfaces 6 and 7) from the system, since the command assumes that the fiber is located in the image plane.

Fiber coupling

As a simplified example of the calculation of fiber coupling efficiency, consider the case of coupling the output of a diode laser into a fiber. A common technique to accomplish this is the use of ball lenses, since small diameter spheres are easier to manufacture than thin lenses of the same diameter. We assume that the diode has far-field divergence half angles of 30° in y and 10° in x . In the Gaussian beam chapter, it is shown that the relationship between beam waist size w_0 and divergence angle θ is

$$\theta = \tan^{-1} \left(\frac{\lambda}{\pi w_0} \right) \quad (10.78)$$

Assuming a wavelength of $0.83 \mu\text{m}$, this leads to beam waists of $w_{0y} = 0.458 \mu\text{m}$ and $w_{0x} = 1.498 \mu\text{m}$. This beam is, of course, elliptical. Since we will be using a rotationally symmetric ball lens, we need to choose an appropriate magnification for coupling to the fiber mode, which is circular. A circular beam with the same cross-sectional area at the waist would have a waist size of $w_0 = (w_{0x}w_{0y})^{1/2} = 0.828 \mu\text{m}$. Thus, assuming a $5 \mu\text{m}$ radius Gaussian mode and the diode waist as the object, we choose a nominal paraxial magnification of $m = -(5/0.828) \approx -6$. Using a 1 mm radius fiber coupling sphere from the Melles Griot catalog, we construct the following system.

SRF	RADIUS	THICKNESS	APERTURE RADIUS	GLASS	SPECIAL
OBJ	0.000000	1.285313	1.2853e-06	AIR	F
AST	0.000000	-1.000000	1.100000	AIR	AS
2	MGLMS202	2.000000	0.720000	FIXED	F
3		6.711875	0.720000	AIR	F
IMS	0.000000	0.000000	9.8887e-06	S	

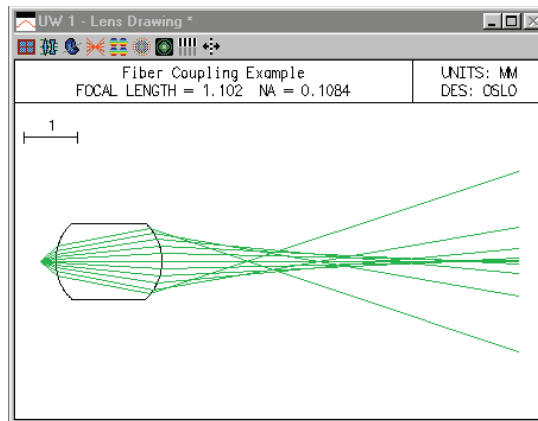

Note that we have located the aperture stop at the center of the sphere. The spot diagram operating conditions are set so that the Gaussian apodization matches our assumed divergence angles of 30° and 10° . Thus the entering spot sizes are $th[0] \cdot \tan(30^\circ) = 1.285 \cdot 0.577 = 0.742 \text{ mm}$ and $th[0] \cdot \tan(10^\circ) = 1.285 \cdot 0.176 = 0.227 \text{ mm}$.

```
*OPERATING CONDITIONS: SPOT DIAGRAM
Aperture divisions:      100.000000
X 1/e^2 entr. irradi.:   0.226635
Use all wavelengths in diagram: On
Use equal image space incrmnts.: off
Diffraction efficiency calcs.: off
Use Gaussian pupil apodization: On
Y 1/e^2 entr. irradi.:   0.742076
P-V OPD for MTF switch:  3.000000
Through-foc. frequency:  25.000000
```

A Gaussian beam trace confirms that the input beam is imaged with a spot size magnification of -6 and the average spot size is $(2.75 \cdot 8.99)^{1/2} = 5 \mu\text{m}$. This Gaussian beam analysis only considers the propagation of the beam in a small region around the axis. This ball lens has a large amount of spherical aberration and the actual diffraction pattern is not the ideal Gaussian shape.

```

*TRACE GAUSSIAN BEAM
WAVELENGTH = 0.830000
SRF  Y SPT SIZE  X SPT SIZE  BEAM AZMTH  Y RFR RAD  X RFR RAD  PHASE AZMTH
      Y WST SIZE  X WST SIZE  Y WST DST  X WST DST
0    0.000458  0.001498  --          --          --          --
      0.000458  0.001498
1    0.742076  0.226640  --          -1.285313  -1.285369  --
      0.000458  0.001498          -1.285313  -1.285313
2    0.164726  0.050331  --          -0.684757  -0.685547  --
      0.000600  0.001964          -0.684748  -0.684503
3    0.645851  0.197248  --          6.711874   6.711661  --
      0.002746  0.008980          6.711752   6.697749
4    0.002746  0.008990  --          -6.610179  -6.610179  --
      0.002746  0.008980          -0.000123  -0.014127
    
```

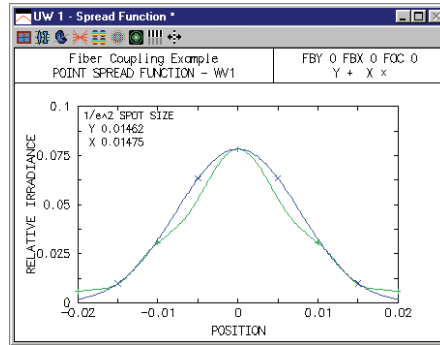

This departure from the 5 μm Gaussian shape of the mode is reflected in the computation of the coupling efficiency, which is about 18%.

```

*FIBER COUPLING EFFICIENCY - WAVELENGTH 1
GAUSSIAN MODE - 1/e**2 RADIUS = 0.005000
FIBER DISPLACEMENT Y -- X --
FIBER TILT TLB -- TLA --
POWER COUPLING = 0.1826 ( -7.385 dB)
AMPLITUDE COUPLING REAL = -0.1981 IMAGINARY = 0.3786
    
```

The above efficiency was calculated at paraxial focus. It is well known, of course, that in the presence of spherical aberration, best focus is not located at the paraxial focus. Introduction of a focus shift can also be used to increase the coupling efficiency. For example, shifting the end of the fiber by 620 μm towards the lens increases the efficiency to just over 40%.

```

*LENS DATA
Fiber Coupling Example
SRF  RADIUS  THICKNESS  APERTURE RADIUS  GLASS  SPE  NOTE
0    --     1.285313  1.2853e-06      AIR
1    --     -1.000000  1.100000 AS     AIR
2    06LMS202 F  2.000000 F  0.800000 F      FIXED F *
3    F      6.711875  0.800000 F      AIR
4    --     -0.620000  0.088442 S
    
```

```

*FIBER COUPLING EFFICIENCY - WAVELENGTH 1
GAUSSIAN MODE - 1/e**2 RADIUS = 0.005000
FIBER DISPLACEMENT Y -- X --
FIBER TILT TLB -- TLA --
POWER COUPLING = 0.4255 ( -3.711 dB)
AMPLITUDE COUPLING REAL = 0.418 IMAGINARY = 0.5008
    
```